

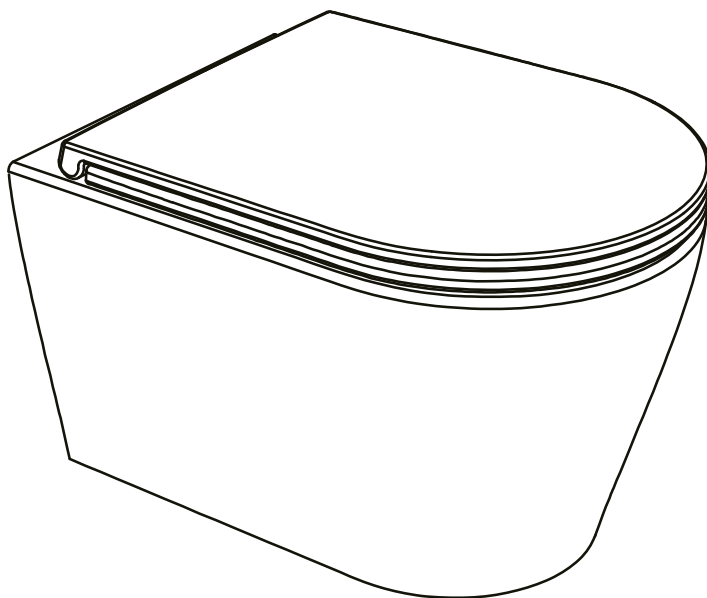

12344023





SAFETY PRECAUTIONS

IMPORTANT SAFETY INSTRUCTIONS

- Read this manual carefully before installing and using the product for the first time. It contains important information for your safety and for the use and care of the product. Keep the instructions for future reference!
- To avoid dangerous situations, do not use the product for purposes other than those described in this manual. Improper use is dangerous and will invalidate the warranty.
- Do not alter or modify the product, product components or accessories.
- Only use accessories recommended by the manufacturer or included in the scope of delivery. Install the product in accordance with the instructions in this user manual.
- Children must not play with plastic bags and packaging material, due to the risk of injury and suffocation. Store such material safely or dispose of it in an environmentally friendly way.
- **Important!** Before use, make sure that the product is in a serviceable condition. The product must not be used if it shows signs of damage or is suspected of being defective.
- Do not use a defective device.
- Make sure that the product is mounted to a sufficiently stable and smooth wall, using only the mounting material included in the scope of delivery.
- When drilling the fastening holes, make sure to choose a location without cables or pipes behind it.
- The product must not be modified in any way.
- Use and maintain only as described in this manual. Any other use or modification to the product is considered as improper use and could cause danger.

- Do not use any cleaning agents that are abrasive or that contain solvents. When using cleaning agents, always observe the instructions of the manufacturer. Do not spray any air fresheners or aromatic products on the seat to eliminate odours. The product can be damaged.
- This product can be used by children aged from 3 years and above and persons with reduced physical, sensory or mental capabilities or lack of experience and knowledge if they have been given supervision or instruction concerning use of the product in a safe way and understand the hazards involved.
- Children should not play with the product. Cleaning and user maintenance shall not be made by children without supervision.

CLEANING

- Do not mix or overdose cleaning agents. Do not use abrasive cleaning agents or cleaning agents containing volatile acids or formic or acetic acid.
- Rinse with water.









MAINTENANCE

- Regularly check all components; clean and replace as needed.

REPLACEMENT PARTS

- Contact our online store or your local HORNBAACH Store for spare parts.

SYMBOLS USED IN THIS DOCUMENT

	Caution: Read the manual carefully!		Use a crosshead screwdriver.
	Caution! Risk of breakage.		Use a rasp or coarse file.
	Caution! Risk of injury.		Use a silicon gun.
	Warning! Risk of accident and injury to persons and serious damage to property.		Wait for 24 hours.
	Use a ruler.		

MOUNTING INSTRUCTIONS

See rear pages:

- I. Scope of delivery
- II. Material needed
- III. Tools needed
- IV. Assembly instructions

TECHNICAL SPECIFICATIONS

Rimless wall-hung toilet	12344023
Dimensions	520 x 363 x 338 mm
Weight	xxx
Finish	according to EN 997/EN 33 305/2011
Material	Ceramic
Colour	White

ENGLISH

I.

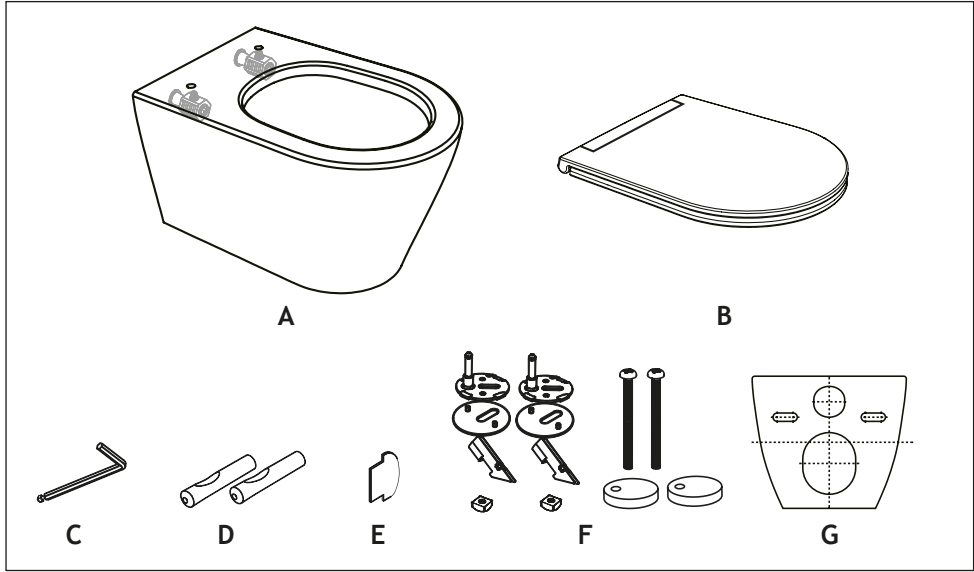

II.

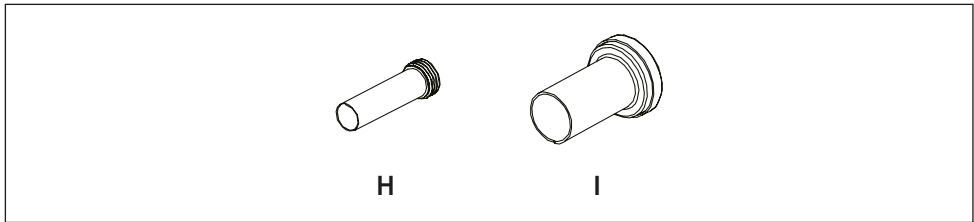

III.

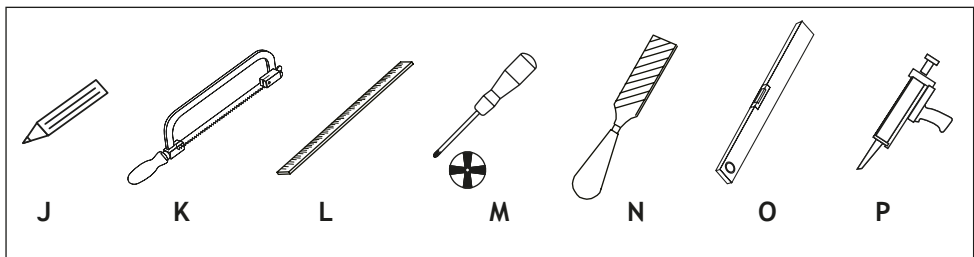

IV.

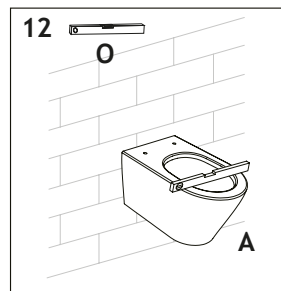
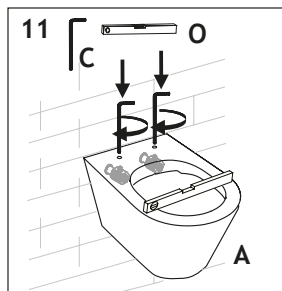
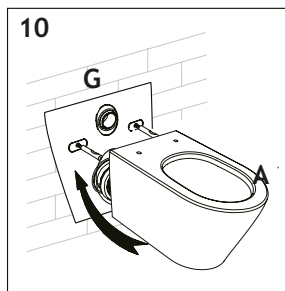
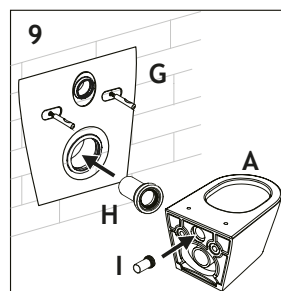
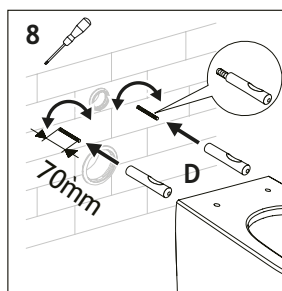
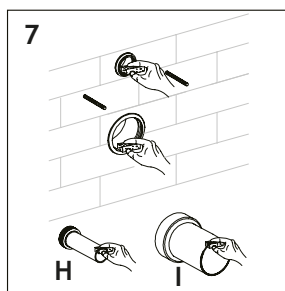
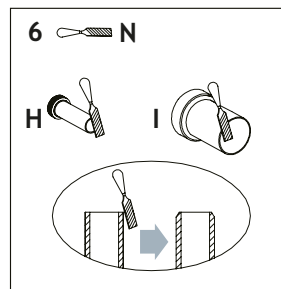
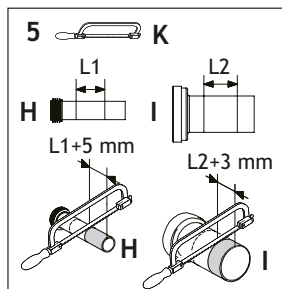
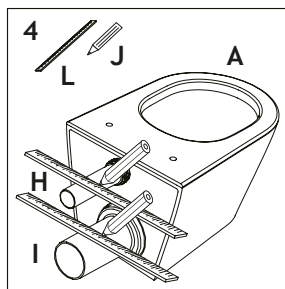
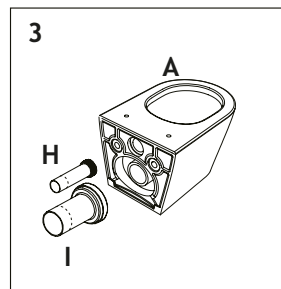
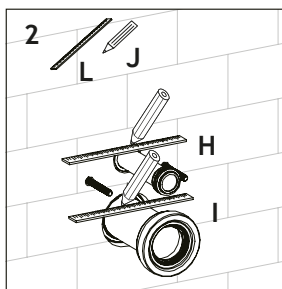
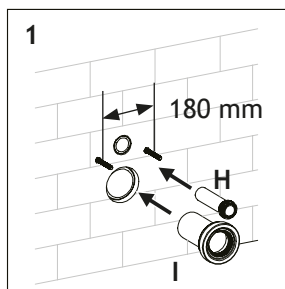

ENGLISH

