

DRAFT

Approval is required with the Technical Illustrator before use with any suggested changes.

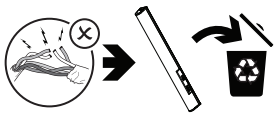

This Product contains a light source of energy efficiency class D

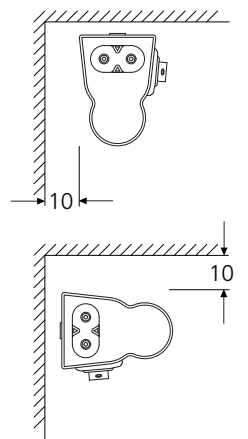
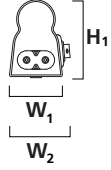
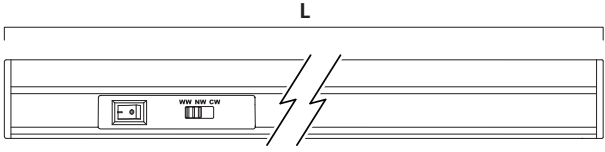
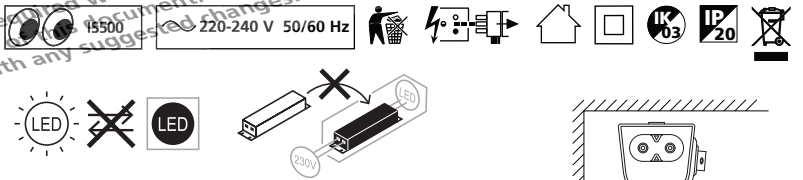

Model - L (mm)	W ₁ (mm)	W ₂ (mm)	H(mm)	D (mm)
SylPipe 3CCT 300	24	27	35	160-200
SylPipe 3CCT 600				400-440
SylPipe 3CCT 900				600-640
SylPipe 3CCT 1200				800-840
SylPipe 3CCT 1500				1000-1040

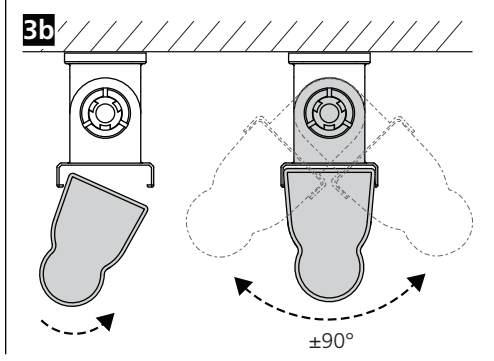
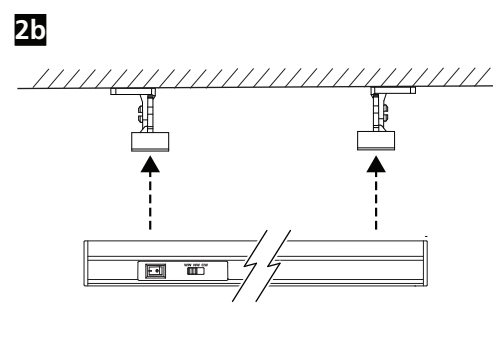
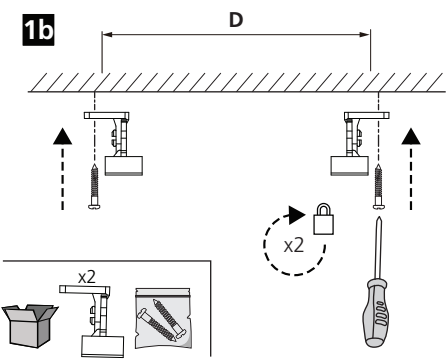
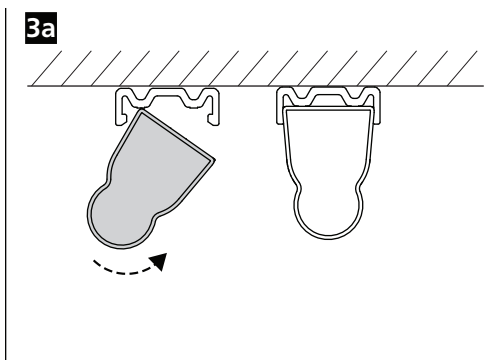
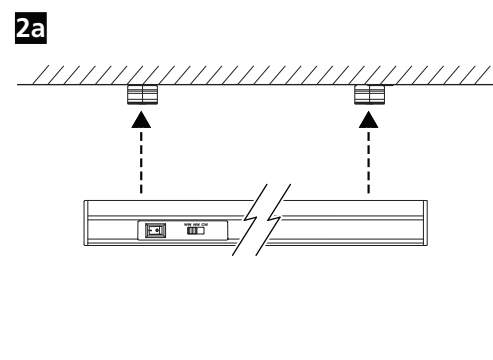
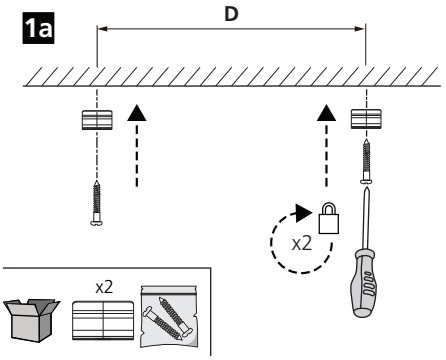

! CCT / Light Output

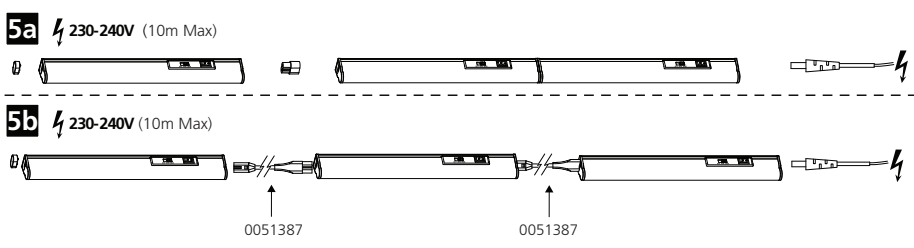
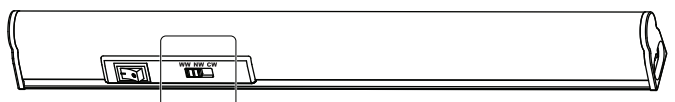
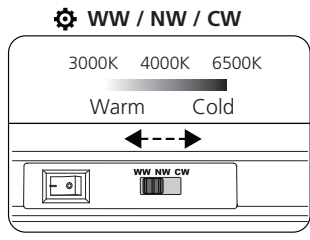

compatible with previous version

20A C-type	(Max. pcs)
0090240, 0090051, 0090056:	35
0090241, 0090052, 0090057:	25
0090242, 0090053, 0090058:	15
0090243, 0090054, 0090059:	10
0090244, 0090055, 0090060:	10
0090063:	14