



DE | Montage- und Bedienungsanleitung

EN | Assembly and operating instructions

FR | Manuel d'installation et de l'utilisateur

IT | Manuale d'installazione e d'uso

NL | Installatie- en gebruiksaanwijzing

SE | Installations- och bruksanvisning

CZ | Montážní a uživatelský manuál

SK | Inštalačná a používateľská príručka

RO | Manual de instalare și utilizare

PL | Instrukcja montażu i obsługi

MALDEN

ART.:10695097
10695089

SICHERHEITSHINWEISE

WICHTIGE SICHERHEITSHINWEISE

Beachten Sie diese Anleitung und bewahren Sie sie für den späteren Gebrauch auf!

Installation

- Trinkwasser-Installationen dürfen nur durch ein in ein Installateurverzeichnis eines Wasserversorgungsunternehmens eingetragenes Installationsunternehmen vorgenommen werden.
- Die örtlichen Installationsvorschriften einhalten, z.B. EN 806, EN 1717.
- Der zulässige Betriebsdruck beträgt maximal 10 bar. Empfohlener Betriebsdruck 0,5 bis 5 bar.
- Die zulässige Höchsttemperatur ist 90 °C. Empfohlene Wassertemperatur: 55 bis 65 °C.
- Nach der Installation und nach längeren Betriebspausen Perlator abschrauben und die Armatur mindestens 1 min. lang bei voll geöffnetem Hahn spülen.
- Die Armatur ist nicht für den öffentlich-gewerblichen Einsatz bestimmt.
- Kinder dürfen auf keinen Fall mit Kunststoffbeuteln und Verpackungsmaterial spielen, da Verletzungs- bzw. Erstickungsgefahr besteht. Solches Material sicher lagern oder auf umweltfreundliche Weise entsorgen.

Betrieb

- In nicht genutzten Wohneinheiten bei Frostgefahr die Armatur vollständig entleeren.
- Größere Differenzen zwischen dem Leitungsdruck von Kalt- und Warmwasser vermeiden.

Reinigung

- Reinigungsmittel nicht mischen oder überdosieren. Keine scheuernden Reinigungsmittel oder solche mit leicht flüchtigen Säuren oder Ameisen- bzw. Essigsäure verwenden.
- Ausreichend mit Wasser nachspülen.







Wartung

- Alle Komponenten regelmäßig überprüfen, reinigen und ggf. austauschen.
- Bei Wartungsarbeiten die Wasserversorgung unterbrechen.

ERSATZTEILE

Für Ersatzteile wenden Sie sich bitte an unseren Online-Shop oder an Ihren HORNBACH-Markt.

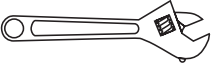
VERWENDETE SYMBOLE

	Vorsicht: Anleitung sorgfältig lesen!		Kontrolle nötig.
	Benötigte Personenzahl		Kaltwasseranschluss
	Zeitdauer: 15 Sekunden		Warmwasseranschluss
	Zeitdauer: 30 Minuten		Dichtheit prüfen. Ggf. mit neuer Dichtung erneut festziehen.
	Rollgabelschlüssel verwenden		Schläuche nicht verdreht, geknickt oder unter Zug montieren.
	SW4.0		Von Hand festziehen / lösen.
	SW2.5		

TECHNISCHE DATEN

	Empfohlen	Maximal
Betriebsdruck	0,5 - 5 bar	10 bar
Wassertemperatur	55 - 65 °C	90 °C
Wasseranschluss	links - Warmwasser / rechts - Kaltwasser	

SAFETY PRECAUTIONS

IMPORTANT SAFETY INSTRUCTIONS

Please observe this manual and keep it for future use!

Installation

- Drinking water installations may only be implemented by an installation company entered in a water supply company's register of installers.
- Observe the local installation regulations, e.g., EN 806, EN 1717.
- The maximum permissible operating pressure is 10 bar; the recommended operating pressure 0.5 to 5 bar.
- The permissible maximum temperature is 90 °C. Recommended water temperature: 55 to 65 °C.
- After the installation, and after longer interruptions to operation, unscrew the aerator and rinse the fitting for at least 1 minute with the tap fully open.
- The fitting is not intended for public commercial use.
- Children must not play with plastic bags and packaging material, due to the risk of injury and suffocation. Store such material safely or dispose of it in an environmentally friendly way.

Operation

- Completely drain the fitting in unused residential units if there is a danger of frost.
- Avoid large differences between the cold and hot water line pressures.

Cleaning

- Do not mix or overdose cleaning agents. Do not use abrasive clean-

ing agents or cleaning agents containing volatile acids or formic or acetic acid.

- Rinse with plenty of water.













Maintenance

- Regularly check all components; clean and replace as needed.
- Shut off the water supply during maintenance work.

REPLACEMENT PARTS

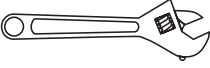
Contact our online store or your local HORNBAACH Store for spare parts.

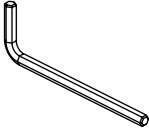
SYMBOLS USED IN THIS DOCUMENT

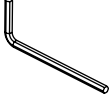
	Caution: Read the manual carefully!		Inspection required.
	Number of people needed		Cold water connection
	Duration: 15 seconds		Warm water connection
	Duration: 30 minutes		Check for leak-tightness. Use a new seal and re-tighten if needed.
	Use a combination wrench		Do not install hoses that are twisted, kinked or under tension.
	SW4.0		Tighten/loosen by hand.
	SW2.5		

TECHNICAL SPECIFICATIONS

	Recommended	Maximum
Operating pressure	0.5 - 5 bar	10 bar
Water temperature	55 - 65 °C	90 °C
Water connection	Left - hot water / right - cold water	

CONSIGNES DE SÉCURITÉ

CONSIGNES DE SÉCURITÉ IMPORTANTES

Respectez ces instructions et conservez-les pour une utilisation ultérieure !

Installation

- Les installations d'eau potable ne peuvent être réalisées que par une entreprise d'installation inscrite dans un registre d'installateurs d'une entreprise de distribution d'eau.
- Respectez les réglementations locales en matière d'installation, par exemple EN 806, EN 1717.
- La pression de service autorisée est de 10 bars maximum. La pression de service recommandée est de 0,5 à 5 bar.
- La température maximale autorisée est de 90 °C. Température de l'eau recommandée : 55 à 65 °C.
- Après l'installation et après de longues périodes d'inactivité, dévissez le mousseur et rincez la robinetterie pendant au moins 1 minute avec le robinet entièrement ouvert.
- Le robinet n'est pas destiné à un usage public/commercial.
- Ne laissez en aucun cas les enfants jouer avec des sacs en plastique et matériels d'emballage, puisque cela les expose à un risque de blessure ou d'étouffement. Rangez ces matières en lieu sûr ou éliminez-les dans le respect de l'environnement.

Fonctionnement

- Dans les unités d'habitation non utilisées, purger complètement le robinet en cas de risque de gel.

- Éviter les différences importantes entre les pressions de l'eau chaude et de l'eau froide.

Nettoyage

- Ne pas mélanger ou surdoser les produits de nettoyage. Ne pas utiliser de produits de nettoyage abrasifs ou contenant des acides volatils ou de l'acide formique ou acétique.
- Rincer abondamment à l'eau.













Entretien

- Vérifier régulièrement tous les composants, les nettoyer et les remplacer si nécessaire.
- Couper l'alimentation en eau lors de l'entretien.

PIÈCES DE RECHANGE

Pour les pièces de rechange, veuillez vous consulter notre boutique en ligne ou vous adresser à votre magasin HORNBAACH.

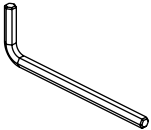
PICTOGRAMMES UTILISÉS

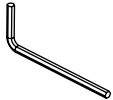
	Prudence : lire attentivement le présent manuel !		Contrôle nécessaire.
	Nombre de personnes nécessaires		Raccordement à l'eau froide
	Durée : 15 secondes		Raccordement à l'eau chaude
	Durée : 30 minutes		Vérifier l'étanchéité. Le cas échéant, resserrer avec un nouveau joint.
	Utiliser une clé à molette		Ne pas monter les flexibles tordus, pliés ou sous tension.
	SW4.0		Serrer/déserrer à la main.
	SW2.5		

DONNÉES TECHNIQUES

	Recommandé	Maximale
Pression de service	0,5 - 5 bars	10 bars
Température d'eau	55 - 65 °C	90 °C
Raccordement à l'eau	gauche - eau chaude/droite - eau froide	

AVVERTENZE DI SICUREZZA

AVVERTENZE DI SICUREZZA IMPORTANTI

Rispettare le presenti istruzioni e conservarle per la successiva consultazione.

Installazione

- Gli impianti per l'acqua potabile possono essere installati solamente da ditte specializzate iscritte nell'apposito registro dell'impresa distributrice.
- Rispettare le norme di installazione locali, ad es. le norme EN 806, EN 1717.
- La pressione di esercizio massima consentita è pari a 10 bar. Pressione di esercizio consigliata: da 0,5 a 5 bar.
- La temperatura massima consentita è di 90 °C. Temperatura dell'acqua consentita: da 55 a 65 °C.
- Successivamente all'installazione e dopo pause di esercizio prolungate svitare l'aeratore per rubinetti e sciacquare la rubinetteria per almeno 1 minuto a rubinetto completamente aperto.
- La rubinetteria non è destinata all'uso pubblico-commerciale.
- Non far giocare i bambini con le buste di plastica e i materiali di imballaggio dell'apparecchio perché rischiano lesioni o soffocamento. Conservare questi materiali in un luogo sicuro o smaltirli nel rispetto dell'ambiente.

Funzionamento

- Nelle unità abitative non utilizzate, se sussiste il pericolo di gelo svuotare completamente la rubinetteria.

- Evitare differenze notevoli tra la pressione presente nella tubazione dell'acqua calda e in quella dell'acqua fredda.

Pulizia

- Non miscelare né sovradosare i detersivi. Non utilizzare detersivi abrasivi o contenenti acidi facilmente volatili, acido formico o acido acetico.
- Sciacquare abbondantemente con acqua.







Manutenzione

- Verificare e pulire regolarmente tutti i componenti, eventualmente sostituirli.
- Se si rendono necessari lavori di manutenzione interrompere l'alimentazione idrica.

RICAMBI

Per i ricambi si prega di rivolgersi al nostro shop online o al proprio mercato HORNBAACH.

SIMBOLI UTILIZZATI

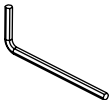
	Attenzione: leggere attentamente le istruzioni!		È necessario effettuare un controllo.
	Numero di persone necessarie		Allacciamento dell'acqua fredda
	Durata: 15 secondi		Allacciamento dell'acqua calda
	Durata: 30 minuti		Verificare la tenuta. Eventualmente serrare nuovamente con una nuova guarnizione.
	Utilizzare una chiave inglese regolabile		Non montare i tubi flessibili distorti, piegati o sottoposti a trazione.
	SW4.0		Serrare/allentare manualmente.
	SW2.5		

DATI TECNICI

	Valore consigliato	Valore massimo
Pressione di esercizio	0,5 - 5 bar	10 bar
Temperatura dell'acqua	55 - 65 °C	90 °C
Allacciamento idrico	a sinistra - acqua calda / a destra - acqua fredda	

VEILIGHEIDSINSTRUCTIES

BELANGRIJKE VEILIGHEIDSAANWIJZINGEN

Neem deze gebruiksaanwijzing in acht en bewaar hem voor toekomstig gebruik!

Installatie

- Drinkwaterinstallaties mogen uitsluitend worden uitgevoerd door een installatiebedrijf dat is ingeschreven in het installateursregister van een waterleidingbedrijf.
- Neem de plaatselijke installatievoorschriften in acht, bijv. EN 806, EN 1717.
- De toegestane werkdruk bedraagt maximaal 10 bar. Aanbevolen werkdruk 0,5 tot 5 bar.
- De maximaal toegestane temperatuur bedraagt 90 °C. Aanbevolen watertemperatuur: 55 tot 65 °C.
- Na installatie en na langere bedrijfsonderbrekingen de beluchter losschroeven en de kraan minimaal 1 minuut spoelen met de kraan volledig open.
- De kraan is niet bedoeld voor openbaar en commercieel gebruik.
- Kinderen mogen nooit met plastic zakken en verpakkingsmaterialen spelen vanwege het gevaar van verwonding en verstikking. Bewaar dit materiaal op een veilige plaats of gooi het op milieuvriendelijke wijze weg.

Gebruik

- In ongebruikte wooneenheden moet bij vorstgevaar de kraan volledig worden leeggemaakt.

- Voorkom grote verschillen tussen de leidingdruk van koud en warm water.

Reiniging

- Meng geen schoonmaakmiddelen en overdoseer deze niet. Gebruik geen schurende schoonmaakmiddelen en geen middelen die vluchtige zuren of mieren- of azijnzuur bevatten.
- Voldoende met water afspoelen.













Onderhoud

- Controleer, reinig en vervang alle onderdelen regelmatig.
- Sluit tijdens onderhoudswerkzaamheden de watertoevoer af.

RESERVEONDERDELEN

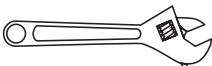
Voor reserveonderdelen kunt u contact opnemen met onze webshop of met uw HORNBACH-winkel.

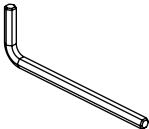
GEBRUIKTE SYMBOLEN

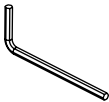
	Let op: Lees de gebruiksaanwijzing aandachtig!		Controle vereist.
	Vereiste aantal personen		Koudwateraansluiting
	Tijdsduur: 15 seconden		Warmwateraansluiting
	Tijdsduur: 30 minuten		Controleer op lekken. Indien nodig opnieuw vastdraaien met een nieuwe afdichting.
	Gebruik een verstelbare sleutel		Monteer slangen niet gedraaid, geknikt of onder spanning.
	SW4.0		Met de hand vast-/losdraaien.
	SW2.5		

TECHNISCHE GEGEVENS

	Aanbevolen	Maximaal
Bedrijfsdruk	0,5 - 5 bar	10 bar
Watertemperatuur	55 - 65 °C	90 °C
Wateraansluiting	links - warm water / rechts - koud water	

SÄKERHETSANVISNINGAR

VIKTIGA SÄKERHETSANVISNINGAR
Läs den här bruksanvisningen och förvar den för senare användning!

Installation

- Dricksvatten-installationer får endast utföras av ett installationsföretag som finns listat i vattenleverantörens installatörsförteckning.
- Följ de lokala installationsföreskrifterna, t.ex. SS-EN 806, SS-EN 1717.
- Tillåtet driftstryck är max. 10 bar. Rekommenderat driftstryck är 0,5 till 5 bar.
- Tillåten högsta temperatur är 90 °C. Rekommenderad vattentemperatur: 55 till 65 °C.
- Skruva av perlatorn och pola armaturen i minst en minuter med fullt öppen kran efter installationen och efter längre driftspausar.
- Armaturen är inte avsedd för offentlig, kommersiell användning.
- Barn får inte under några som helst omständigheter leka med plastpåsar och förpackningsmaterial eftersom de då löper risk att skadas eller kvävas. Förvara därför sådant material säkert eller avfallshantera det miljövänligt.

Drift

- Töm armaturen helt i oanvända bostäder om det föreligger risk för frost.
- Undvik större differenser mellan ledningstryck för kall- och varmvatten.

Rengöring

- Blanda inte och överdosera inte rengöringsmedel. Använd inte repande rengöringsmedel eller

rengöringsmedel som innehåller lättflyktiga syror eller myr- resp. ättiksyra.

- Spola av med tillräckligt med vatten.













Underhåll

- Kontrollera, rengör och byt vid behov alla komponenter regelbundet.
- Stäng av vattentillförseln vid underhållsarbeten.

RESERVDELAR

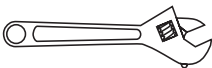
Kontakta vår online-shop eller din HORNBAACH-butik vid behov av reservdelar.

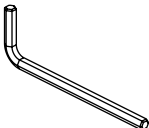
ANVÄNDA SYMBOLER

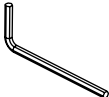
	Observera! Läs bruksanvisningen noga!		Kontroll krävs.
	Nödändigt antal personer		Kallvattenanslutning
	Tidsperiod: 15 sekunder		Varmvattenanslutning
	Tidsperiod: 30 minuter		Kontrollera tätheten. Dra vid behov åt igen med en ny tätning.
	Använd skiftnyckel		Montera inte slangar vridna, knäckta eller utdragna.
	SW4.0		Dra åt/lossa för hand.
	SW2.5		

TEKNISKA DATA

	Rekommenderat	maximalt
driftstryck	0,5 - 5 bar	10 bar
Vattentemperatur	55 - 65 °C	90 °C
Vattenanslutning	vänster – varmvatten/höger – kallvatten	

BEZPEČNOSTNÍ POKYNY

DŮLEŽITÉ BEZPEČNOSTNÍ POKYNY
Dodržujte tento návod a uschovejte jej pro pozdější použití!

Instalace

- Instalace pitné vody smějí provádět pouze instalační firmy uvedené v adresáři instalatérů podniku zásobování vodou.
- Dodržujte místní instalační předpisy, např. EN 806, EN 1717.
- Přípustný provozní tlak činí maximálně 10 bar. Doporučený provozní tlak 0,5 až 5 bar.
- Přípustná nejvyšší teplota je 90 °C. Doporučená teplota vody: 55 až 65 °C.
- Po instalaci a po delších provozních pauzách odšroubujte perlátor a armaturu vyplachujte minimálně po dobu 1 min. při úplně otevřeném kohoutu.
- Armatura není určena pro veřejné průmyslové a živnostenské použití.
- Děti si v žádném případě nesmějí hrát s plastovými sáčky a obalovým materiálem, protože existuje nebezpečí úrazu příp. udušení. Takový materiál bezpečně skladujte nebo zlikvidujte způsobem šetrným k životnímu prostředí.

Provoz

- V nepoužívaných obytných jednotkách při nebezpečí mrazu armaturu úplně vyprázdněte.
- Zabraňte větším rozdílům mezi tlakem ve vedení u studené a teplé vody.

Čištění

- Čisticí prostředky nesmíchávejte ani nadměrně nedávkujte. Nepoužívejte žádné abrazivní

čisticí prostředky nebo prostředky, které obsahují snadno těkavé kyseliny nebo kyselinu mravenčí příp. octovou.

- Opláchněte dostatečným množstvím vody.

Údržba

- Všechny komponenty pravidelně kontrolujte, čistěte a příp. je vyměňte.
- Při provádění údržbářských prací přerušete zásobování vodou.

NÁHRADNÍ DÍLY

Ohledně náhradních dílů se prosím obraťte na náš online shop nebo na Váš trh HORNBAACH.

POUŽITÉ SYMBOLY



Pozor: Návod si bedlivě přečtěte!



Počet osob, které jsou potřeba



Doba trvání:
15 sekund



Doba trvání:
30 minut

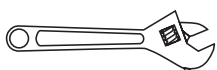

Použijte nastavitelný klíč

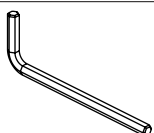

SW4.0

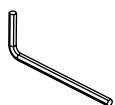

SW2.5



Nutná kontrola.



Připojení studené vody



Připojení teplé vody



Zkontrolujte těsnost. Příp. znovu pevně utáhněte s novým těsněním.



Hadice nemontujte zkroucené, zalomené nebo v tahu.



Rukou dotáhněte / povolte.

TECHNICKÉ ÚDAJE

	Doporučeno	Maximálně
Provozní tlak	0,5 - 5 bar	10 bar
Teplota vody	55 - 65 °C	90 °C
Připojení vody	vlevo - teplá voda / vpravo - studená voda	

BEZPEČNOSTNÉ POKYNY

DÔLEŽITÉ BEZPEČNOSTNÉ POKYNY
Dodržiavajte tento návod a uscho-
vajte na neskoršie použitie!

Inštalácia

- Inštalácie pitnej vody smie re-
alizovať iba inštalačný podnik
zapísaný v zozname inštalatérov
vodohospodárskeho podniku.
- Dodržiavajte miestne inštalačné
predpisy, napr. EN 806, EN 1717.
- Dovolený prevádzkový tlak činí
maximálne 10 bar. Odporúčaný
prevádzkový tlak 0,5 až 5 bar.
- Dovolená maximálna teplota je 90
°C. Odporúčaná teplota vody: 55
až 65 °C.
- Po inštalácii a po dlhších prestávk-
ach v prevádzke odskrutkujte
perlátor a vypláchnite armatúru
minimálne 1 min. pri plne otvore-
nom kohúte.
- Armatúra nie je určená na verejno-
komerčné použitie.
- Deti sa nesmú v žiadnom prípade
hrať s plastovými vreckami a oba-
lovým materiálom, pretože exis-
tuje nebezpečenstvo poranenia,
resp. zadusenia. Takýto materiál
skladujte bezpečne alebo zlikvidu-
jte ekologickým spôsobom.

Prevádzka

- V nepoužívaných bytových jed-
notkách pri nebezpečenstve
mrazu armatúru úplne vyprázd-
nite.
- Zabráňte väčším rozdielom medzi
tlakom potrubia studenej a teplej
vody.

Čistenie

- Nepremiešajte ani nepredávajte
čistiaci prostriedok. Nepoužívajte
žiadne drhnuce čistiace prostried

ky alebo podobné prostriedky s
ľahko prchavými kyselinami alebo
kyselinou mravčou, resp. octovou.

- Vypláchnite s dostatočným
množstvom vody.

Výstraha

- Všetky komponenty pravidelne
kontrolujte, čistite a príp. vy-
mieňajte.
- Pri údržbárskych prácach pre-
rušte zásobovanie vodou.

NÁHRADNÉ DIELY

Ohľadom náhradných dielov sa obráťte
na náš internetový obchod alebo na
váš market HORNBAACH.

POUŽITÉ SYMBOLY



Pozor: Prečítajte si starostlivo návod na obsluhu!



Je potrebná kontrola.



Potrebný počet osôb



Prípojka studenej vody



Čas trvania:
15 sekúnd



Prípojka teplej vody



Čas trvania:
30 minút



Skontrolujte tesnosť.
Príp. nanovo utiahnite s
novým tesnením.

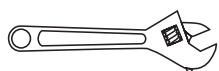

Použite prestaviteľný
kľúč



Hadice nepretáčajte, ne-
prelamujte ani nemontu-
jte pod ťahom.

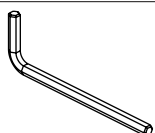

SW4.0



Utiahnite pevne rukou/
uvoľnite.

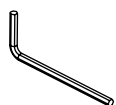

SW2.5

TECHNICKÉ ÚDAJE

	Odporúčané	Maximálny
prevádzkový tlak	0,5 - 5 bar	10 bar
Teplota vody	55 - 65 °C	90 °C
Prípojka vody	vľavo – teplá voda/vpravo – studená voda	

INSTRUCȚIUNI DE SIGURANȚĂ

INSTRUCȚIUNI DE SIGURANȚĂ IMPORTANTE

Respectați prevederile din acest manual și păstrați manualul pentru utilizările ulterioare!

Montarea

- Instalațiile de apă potabilă pot fi executate numai de către o firmă de instalații înregistrată în lista instalatorilor unei firme de alimentare cu apă.
- Respectați prescripțiile locale de instalare, de ex. EN 806, EN 1717.
- Presiunea de lucru admisibilă este de 10 bar. Presiunea de funcționare recomandată este între 0,5 și 5 bar.
- Temperatura maximă admisibilă este de 90 °C. Temperatura recomandată a apei este între: 55 bis 65 °C.
- După instalare și după o perioadă de neutilizare mai îndelungată deșurubați perlatorul și spălați bateria cu robinetul complet deschis timp de cel puțin 1 minut.
- Bateria nu este destinată unei utilizări publice industriale.
- Copiii nu au voie în niciun caz să se joace cu pungile din plastic și cu materialul de ambalare, deoarece există pericol de rănire, respectiv de asfixiere. Depozitați în siguranță astfel de materiale sau eliminați-le ca deșeuri în mod ecologic.

Utilizare

- În unitățile de locuit neutilizate, în caz de pericol de îngheț goliți complet bateria.

- Evitați diferențele mari de presiune între presiunea conductelor de apă rece și caldă.

Curățare

- Nu amestecați și nu supradozați detergenții. Nu folosiți mijloace de curățare abrazive sau cu conținut de acizi volatili, sau acid formic, respectiv acid acetic.
- Clătiți cu apă suficientă.













Întreținere

- Verificați, curățați și eventual înlocuiți toate componentele în mod regulat.
- La efectuarea lucrărilor de întreținere întrerupeți alimentarea cu apă.

PIESE DE SCHIMB

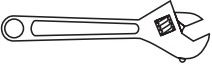
Pentru piese de schimb adresați-vă magazinului nostru online sau magazinului dvs. Hornbach.

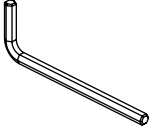
SIMBOLURI FOLOSIRE

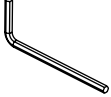
	Precauție: Citiți cu atenție instrucțiunile de utilizare!		Este necesară verificarea.
	Numărul necesar de persoane		Racord de apă rece
	Durata de timp: 15 secunde		Racord de apă caldă
	Durata de timp: 30 de minute		Verificați etanșeitarea. Eventual strângeți din nou cu o garnitură de etanșare nouă.
	Folosiți o cheie reglabilă		Nu montați furtunul în așa fel ca acesta să fie răsucit, răsfânt sau sub rațiune.
	SW4.0		Se strânge/se slăbește cu mâna.
	SW2.5		

DATE TEHNICE

	Recomandat	Maxim
Presiune de lucru	0,5 - 5 bar	10 bar
Temperatura apei	55 - 65 °C	90 °C
Racord de apă	stânga - apă caldă / dreapta - apă rece	

INSTRUKCJE BEZPIECZEŃSTWA

WAŻNE INSTRUKCJE BEZPIECZEŃSTWA

Postępuj zgodnie z tymi instrukcjami i zachowaj je do późniejszego wykorzystania!

Instalacja

- Instalacje wody pitnej mogą być wykonywane wyłącznie przez firmę instalacyjną zarejestrowaną w katalogu instalatorów przedsiębiorstwa wodociągowego.
- Przestrzegać lokalnych przepisów instalacyjnych, np. EN 806, EN 1717.
- Dopuszczalne ciśnienie robocze wynosi maksymalnie 10 barów. Zalecane ciśnienie robocze od 0,5 do 5 bar.
- Maksymalna dopuszczalna temperatura wynosi 90 °C. Zalecana temperatura wody: od 55 do 65 °C.
- Odkręć aerator po zamontowaniu i po dłuższych przerwach w pracy i płucz kran przez co najmniej 1 minutę przy całkowicie otwartym kranie.
- Kran nie jest przeznaczony do publicznego, komercyjnego użytku.
- Dzieciom nie wolno bawić się plastikowymi torbami i materiałami opakowaniowymi, ponieważ istnieje ryzyko obrażeń lub uduszenia. Przechowuj taki materiał w bezpieczny sposób lub zutylizuj go w sposób przyjazny dla środowiska.

Operacja

- W nieużywanych lokalach mieszkalnych, gdy istnieje ryzyko mrozu, kran opróżnij całkowicie.

- Duże różnice między ciśnieniem w przewodzie zimnego i Unikaj gorącej wody.

Czyszczenie

- Nie mieszać ani nie przedawkować środków czyszczących. Bez ściernych środków czyszczących lub tych z lotnymi kwasami lub kwas mrówkowy lub octowy używać.
- Dokładnie spłucz wodą.













Konserwacja

- Wszystkie komponenty regularnie sprawdź, wyczyść i wymień w razie potrzeby.
- Przerwij dopływ wody podczas prac konserwacyjnych.

CZĘŚCI ZAMIENNE

W celu uzyskania części zamiennych prosimy o kontakt z naszym sklepem internetowym lub lokalnym sklepem HORNBACH.

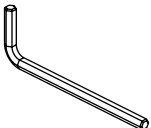
UŻYWANE SYMBOLE

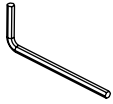
	Uwaga: Należy uważnie przeczytać instrukcje!		Kontrola jest konieczna.
	Wymagana liczba osób		Przyłącze zimnej wody
	Czas trwania: 15 sekund		Przyłącze ciepłej wody
	Czas trwania: 30 minut		Sprawdź szczelność. W razie potrzeby ponownie dokręć nową uszczelką.
	Użyj kluczy nastawnych		Nie instaluj węży skrzyżowanych, zagiętych lub pod napięciem.
	SW4.0		Dokręć / poluzuj ręcznie.
	SW2.5		

DANE TECHNICZNE

	Zalecane	Maksimum
Ciśnienie robocze	0,5 - 5 bar	10 bar
Temperatura wody	55 - 65 °C	90 °C
Podłączenie wody	lewy - Gorąca woda / prawy - Zimna woda	

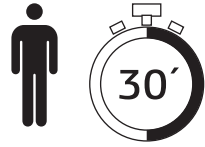
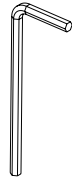
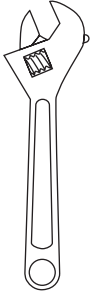
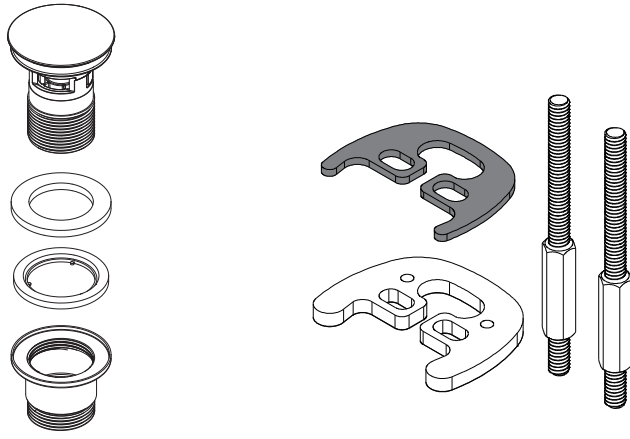

1

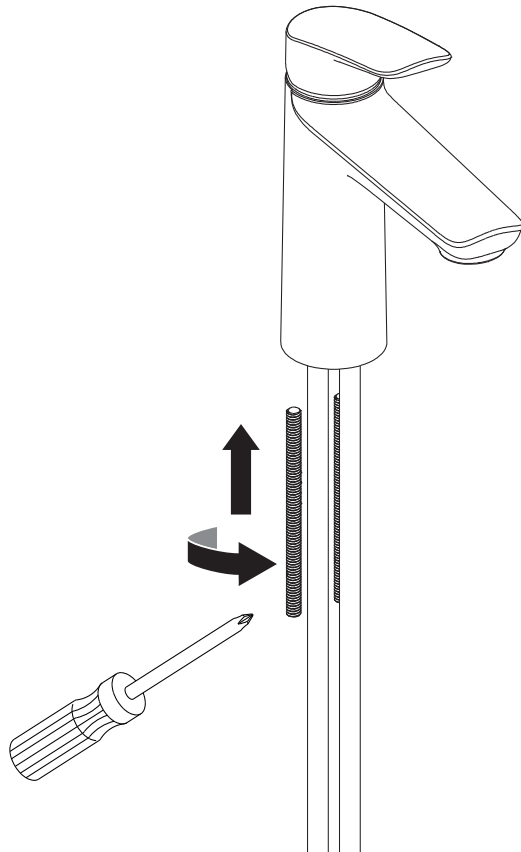

2

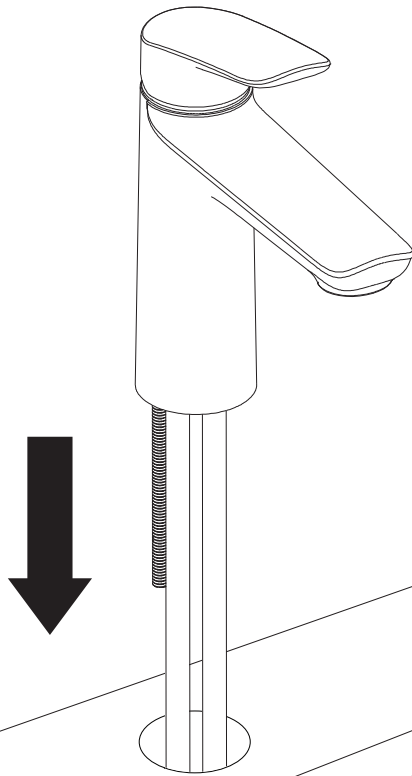

3

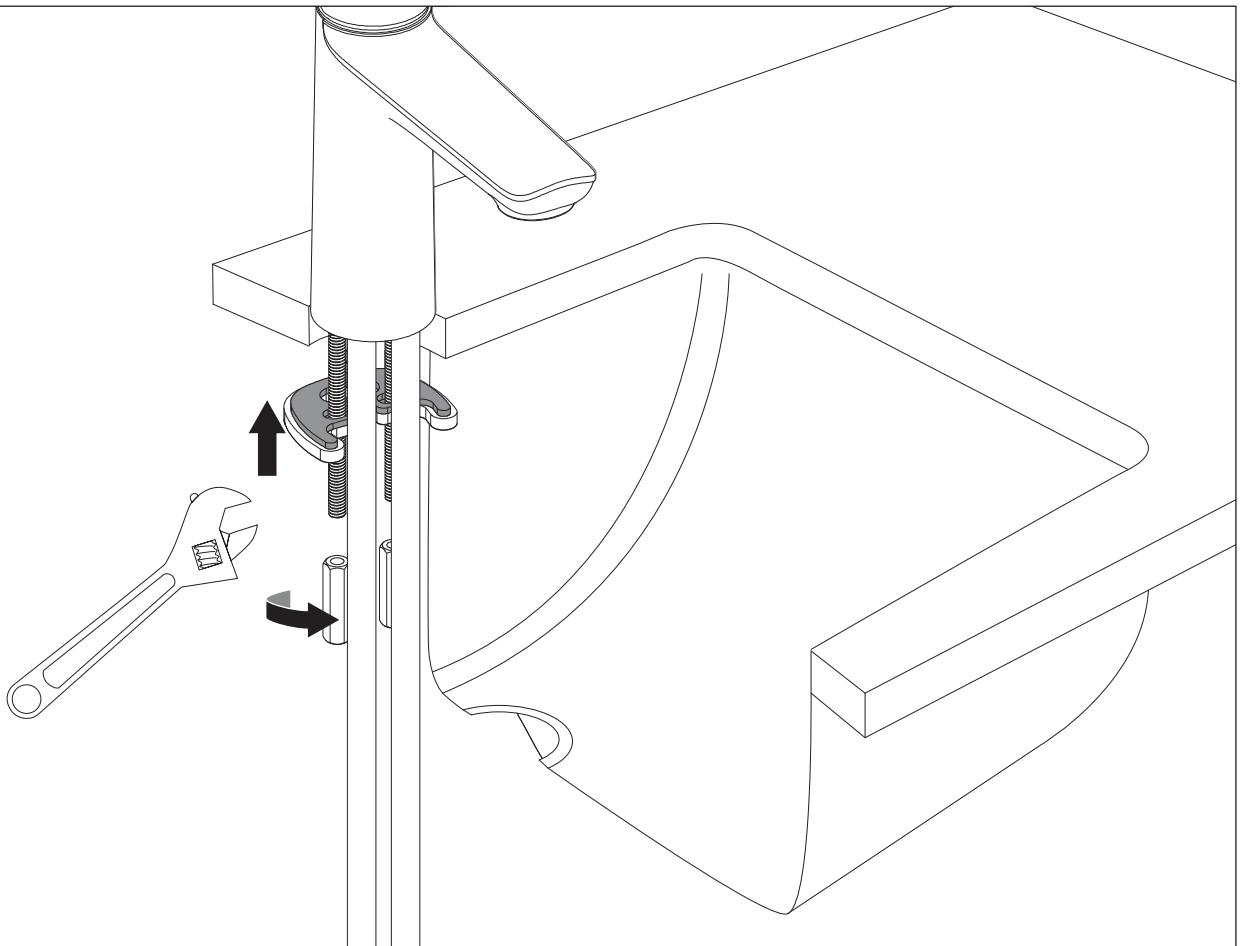

4

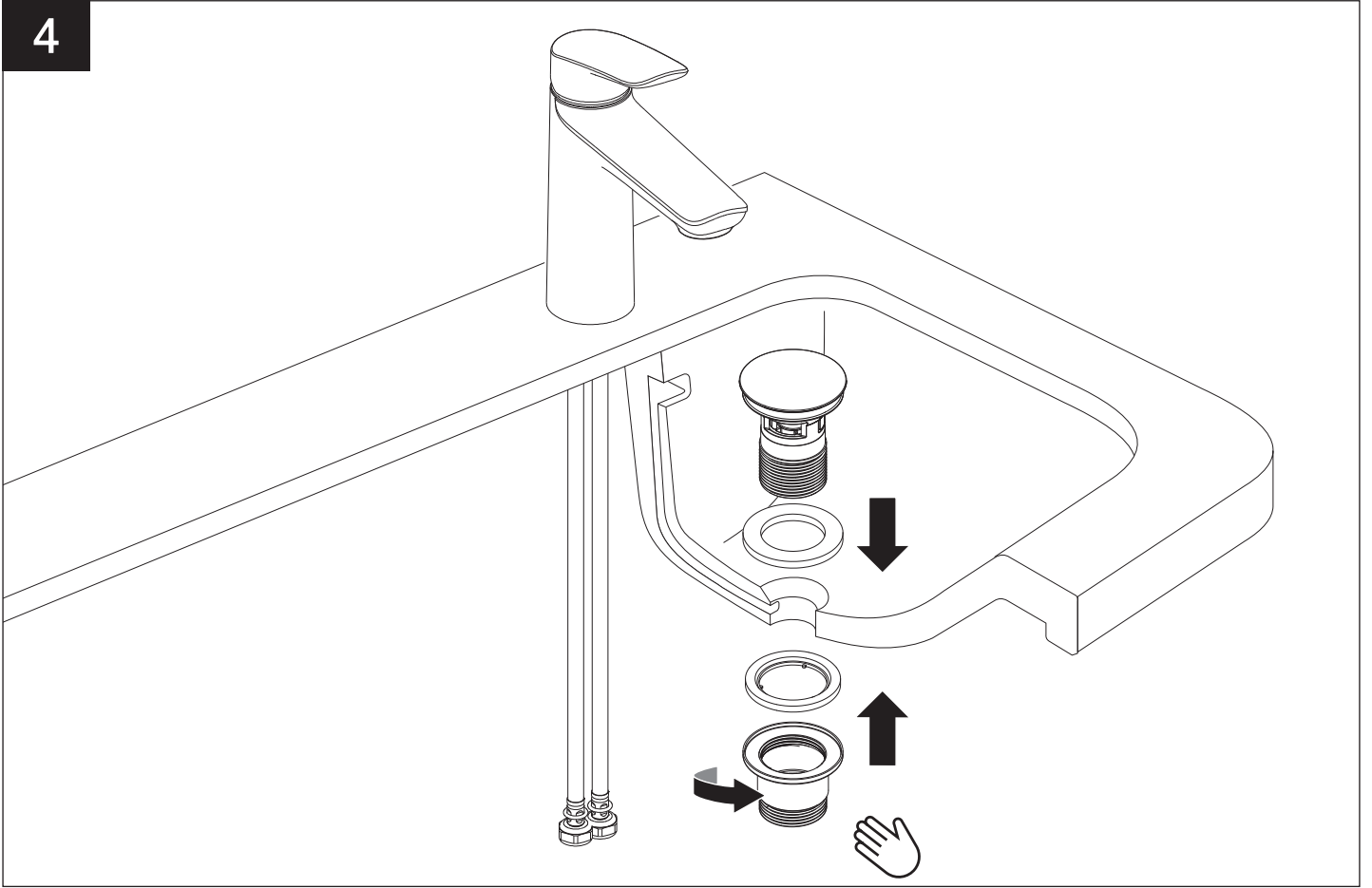

5

